

User Manual

Hybrid Solar Inverter (EU Three-Phase)



Contents

ABOUT THIS MANUAL	01
Purpose	01
Safety Instructions	01
WARNING MARKS	03
EQUIPMENT LABEL	04
PRODUCT OVERVIEW	05
About the Product	05
Product Appearance	05
Functional Features	06
Basic System Architecture	06
PRODUCT INSTALLATION	07
Safety Guidance	07
Installation Environment	10
Mounting the Unit	10
Connection of PV Cable	11
Connection of Battery Cable	12
LOAD and GRID Links	12
Communication Port	13
WiFi Dongle Connection	14
Wiring System for Inverter	14
OPERATING INSTRUCTIONS	15
Power ON/OFF	15
Operation and Display Pane	15
LCD Display Icons	16
Menu Function	16
Working Mode	19
THINGS-X APP OPERATION INSTRUCTIONS	21
Download App	21
Register & Login	21
Power Station Creation	22
Bind Collector	22
Collector Networking Step Explanation	24
TECHNICAL PARAMETERS	25
Battery Parameters	25
PV Input Parameters	25
Output Parameters	26
Efficiency and Protection	27
General Parameters	28
Performance and Safety Regulation	28
WARNING CODE TABLE	29
FAULT CODE TABLE	31

ABOUT THIS MANUAL

Purpose

This manual describes the assembly, installation, operation, warning code and fault code of this unit. Please read this manual carefully before installations and operations. Keep this manual for future reference.

Safety Instructions

 **WARNING:** This chapter contains important safety and operating instructions. Read and keep this manual for future reference.

Necessary conditions for inverter installation:

The installation of energy storage photovoltaic inverters must fully comply with the standards and regulations of the national and local power grids. Please read and understand all instructions in this manual, familiarize yourself with the relevant safety signs, and perform installation and commissioning. In accordance with national and state/provincial regulations, access to the grid can only be approved by the power department and can only be operated by qualified electrical engineers. For maintenance or repair, contact your local authorized maintenance center. For information about your local licensing center, please contact the franchisor. Do not maintain it by yourself; otherwise, personal injury or property damage may occur. Before installation and maintenance, use the DC switch to disconnect the HVDC power supply. Otherwise, the resulting high pressure can cause serious personal injury.

Requirements for installation and maintenance personnel:

During the operation of the inverter, some parts may be charged and some parts may heat up. Improper use, installation, or operation may result in serious injury or property damage. Transportation, loading and unloading, installation, start-up and maintenance must be carried out by qualified electrical engineers (all effective accident prevention measures in the user's country must be observed!). The manufacturer shall not be liable for personal injury or property damage caused by improper use.

Conditions of assembly:

Energy storage photovoltaic inverters should be assembled according to the detailed instructions in the following sections. The inverter should be placed on an object with a suitable load capacity and placed vertically. Equipment should be installed in the appropriate place, and ensure that there is enough fire escape space, in order to facilitate maintenance in the event of failure. Ventilation conditions should be met to ensure sufficient circulating air for cooling. The humidity of the air during assembly should not exceed 90%.

Conditions of transport:

The inverter should be in the best electrical and mechanical condition when leaving the factory. Inverters must be shipped in their original packaging or any other suitable packaging to ensure the safety of the equipment during transportation. The transportation company shall be responsible for any damage caused to the equipment during transportation. When taking delivery, check the inverter thoroughly. If you find that the packaging problem may cause damage to the inverter, or there is obvious damage, please notify the transportation company immediately. If necessary, you can ask your PV system installer or distributor for help.

Precautions for electrical connection:

When handling powered inverter, please comply with the current national regulations on the prevention of electrical accidents. Before making an electrical connection, be sure to cover the photovoltaic panel with an opaque material or disconnect the DC circuit breaker, because sunlight can cause the photovoltaic array to produce dangerous voltage. When installing a battery, identify the positive and negative terminals and disconnect the battery. Installation must be performed by a professional electrical engineer who has been trained to fully read this manual and understand the relevant safety matters. The inverter must be approved by the local power board to be connected to the grid and electrically connected by a professional electrical engineer.

Notes on work operation:

Contact with power grids or equipment terminals may result in death by electrocution or fire! Do not touch any terminal or conductor connected to the power grid circuit. Please read the instructions or safety documents relating to electrical connections carefully. During operation, some internal components may be heated. Please wear protective gloves.

Maintenance and repair considerations:













Before performing any maintenance or repair, disconnect the inverter from the power grid and then disconnect the electrical connection on the DC side. Wait at least 5 minutes for all internal components to be discharged before starting maintenance or repair. Any faults that affect the safety of the inverter must be resolved before restarting the inverter. For repairs, contact your local authorized service center. Do not disassemble the internal components of the inverter without authorization. The manufacturer does not assume any warranties or joint and several liability for the damage caused thereby.

Inverter EMC / Noise level:

Electromagnetic compatibility (EMC) refers to the ability of electrical equipment to perform its function in a specified electromagnetic environment without causing faults and errors, and without causing unacceptable effects on the environment. Therefore, EMC represents the quality characteristics of electrical equipment, inherent noise immunity, immunity to internal electrical noise, immunity to external noise, immunity to external system electromagnetic noise, noise emission level, electromagnetic emission impact on the environment and so on. High voltage circuits in frequency converters can be life-threatening! Only professional electrical engineers can operate this product: minors, disabled people, mental patients should not use; It should be installed out of the reach of children.



WARNING MARKS

Warning marks inform users of conditions which can cause serious physical injury or death, or damage to the device. They also tell users how to prevent the dangers. The warning marks used in this operation manual are shown below:

Symbol	Symbol Name	Symbol Meaning
	There is a risk of residual voltage in the inverter!	For a period of time after disconnecting DC side of the inverter, the internal capacitor may still be charged; it is necessary to wait 5 minutes for the capacitor to fully discharge prior to maintenance.
	Beware of high voltage and electric shock.	There is high voltage during running of the inverter. All operations involving the inverter must be performed by trained professional electrical technicians.
	Beware of hot surface.	The housing of the inverter is hot during running, and please do not touch it.
	Conforming to EU standard (CE) authentication.	This product complies with the CE authentication standard.
	Earthing terminal.	Connect the inverter with the earthing bar, to protect the inverter.
	Read the Manual.	Please read the Manual prior to installation of the inverter.
	Positive and negative electrode identification.	Remind the user of the polarity of electrical connection.
	Temperature identification.	Indicate the permissible temperature range.
	This side up.	The inverter must always be transported, handled and stored in such a way, with the arrow pointing upwards.
	RCM identification.	The product meets the requirements of the applicable Australian Standard.
	WEEE	The DC input terminals of the inverter must not be grounded.
	Ground insulation	Do Not put it in the waste bin! Recycle it by licensed professional!

EQUIPMENT LABEL

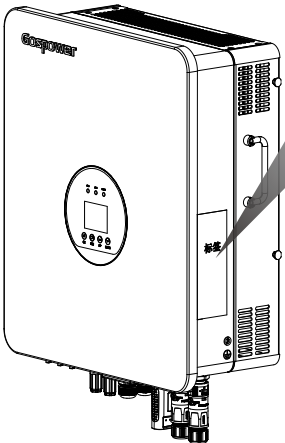
This label is located on the right side of the chassis and provides information on the inverter model, technical parameters, and warning signs. Do not tear it off, and please read it carefully.

	<h3>Gospower</h3>
	GUANGDONG GOSPOWER ELECTRIC TECHNOLOGY CO.,LTD.
	Model : GPEX-15KH3 Product Type : Hybrid Solar Inverter
	PV Input Parameter Max PV Input Power : 22.8kW Max PV Volt : 1000V Mppt Input Volt : 200-850Vdc Max Input Current PV1/PV2 : 15A/30A Max PV Isc PV1/PV2 : 19.5A/40A
	Grid Parameter Rated Output Power : 15kVA Max AC Apparent Input Current : 36A Max AC Apparent Output Current : 24A Grid Voltage : 3L/N/PE 230/400Vac Grid Frequency : 50/60Hz Power Factor Range : -0.8~+0.8
	Back-up Output Parameter Max AC Apparent Output Power : 15kVA Max AC Apparent Output Current : 24A Back-up Voltage : 3L/N/PE 230/400Vac Back-up Frequency : 50/60Hz
	Battery Parameter Battery Voltage Range : 160-800Vdc Max Charging Current : 50A Max Discharging Current : 50A
	System Dimensions (L * W * H) : 520*430*200mm Weight : 31Kg Max Efficiency : 98% Ingress Protection : IP65 Ambient Temperature : -20-60°C (>45°C derating) Protection Level : Class I
	
	Importer : Made in China Product Serial number :

PRODUCT OVERVIEW

About the Product

The inverter is a three-phase energy-storage PV inverter integrating the PV grid-connected inverter and battery storage. The inverter has a variety of working modes to adapt to diverse use needs. The display panel and APP can provide users with intuitive information display and convenient parameter setting.

Product Appearance

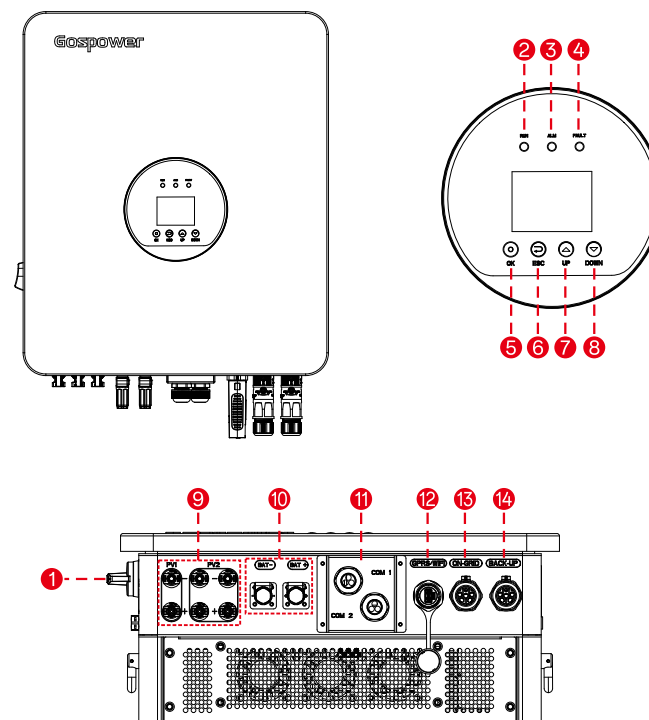

- | | |
|-------------------------|---|
| 1. DC switch | 8. DOWN button |
| 2. Normal Run indicator | 9. PV input terminal |
| 3. Alarm indicator | 10. Battery input terminal |
| 4. Fault indicator | 11. COM (communication connection port) |
| 5. OK button | 12. GPRS/WIFI |
| 6. ESC button | 13. Grid connection port |
| 7. UP button | 14. Load connection port |

Functional Features

The energy-storage PV inverter allows up to 5% overload, to achieve maximum power output. The inverter does not require an external residual current device, as it has integrated with a RCMU. If local regulations require the application of external residual current device, either type A or type B RCD is compatible with the inverter. The action current of external residual current device should be 300mA.

- 230V/380V pure sine wave inverter.
- Spontaneous self-use and grid connection. Customize battery and grid power supply priorities.
- Support WIFI remote monitoring and setting.
- Two PV inputs, maximum MPPT voltage 850V.
- The maximum charge and discharge efficiency of the battery is 97%.
- Input one set of batteries, maximum charge and discharge current 50A.
- Supports high-voltage stacked batteries (160-800V).
- Intelligent monitoring, RS485/WiFi/Bluetooth/GPRS(optional).
- Fan intelligent heat dissipation, improve efficiency and reduce noise.

Basic System Architecture

The following illustration shows basic application for this inverter/charger. It also includes following devices to have a complete running system:

- Utility
- PV modules

Consult with your system integrator for other possible system architectures depending on your requirements.

This inverter can provide power for all kinds of appliances in home or office environment, including motor-type appliances such as fan, refrigerator and air conditioner.

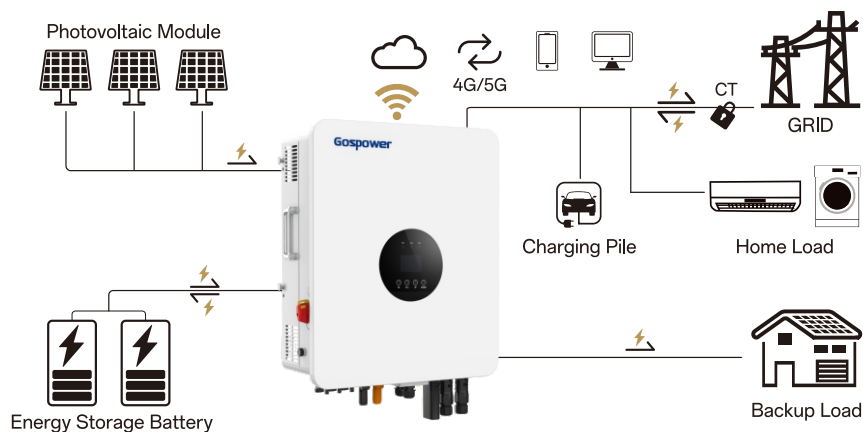

PRODUCT INSTALLATION

Safety Guidance

⚠️ Precautions

- Do not install inverter on inflammable materials. Do not install inverter in the areas storing flammable and explosive materials .
- The housing and cooling fin are quite hot during running of the inverter, so do not install inverter in a place where you may inadvertently touch it.
- For transportation and moving of the inverter, the weight of the inverter shall be considered. The proper installation position and surface shall be selected. The inverter shall be installed by at least two persons.





⚠️ Inspect the outer packaging materials

Packaging materials and components may be damaged during transportation. Therefore, please inspect the outer packaging materials before installing the inverter. Inspect the outer packaging materials for damage, e.g. holes and cracks. In the case of any damage to the inverter, please do not open the package, and contact the dealer as soon as possible. You are recommended to remove the packaging materials within 24 hours prior to installation of the inverter.

⚠️ Check the delivery List

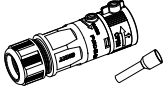
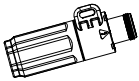
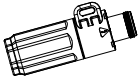
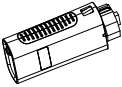

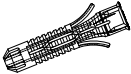
Upon unboxing of the inverter, check the integrity of the deliverable. In the case of any damage or loss of components, please contact the dealer.







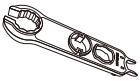
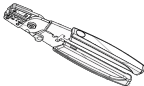
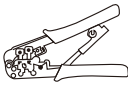

NO.	Figure	Description	Quantity
01		Inverter	1pcs
02		Wall mounting bracket	1pcs
03		Inner hexagon screws	4pcs
04		PV+ plug connector Metal terminal	3pcs 3pcs
05		PV- plug connector Metal terminal	3pcs 3pcs

07		AC plug connector Metal terminal	2pcs 10pcs
08		BAT+ plug connector (orange)	1pcs
09		BAT+ plug connector (black)	1pcs
10		WiFi Dongle	1pcs
11		Current transformer (CT)	3pcs
12		M8*50 Self-tapping screw	4pcs
13		Screw fixing seat	4pcs
14		User Manual	1pcs

! Tools

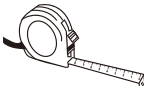
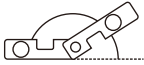
Prepare the tools for installation and electrical connection.

NO.	Tools	Description	Functions
01		Impact drill bit diameter 10mm is recommended	For drilling on the wall
02		Flat-head screwdriver	For removing, installing screws and wiring
03		Hex key	Hex key diameter 5mm is recommended

04		Cross screwdriver	For removing, installing screws and wiring
05		Removal tool	For removing PV terminals
06		Wire stripper	For stripping the wire
07		Wire crimper	For crimping cables
08		Multimeter	For checking whether the cable wiring, positive and negative battery terminals are correct, and whether the earthing is reliable
09		Wrench with the opening ≥ 13 mm	For fastening the self-tapping screw
10		Marking pen	For marking the holes
11		Tape measure	For measuring the distance
12		Leveling instrument	For ensuring the leveling of the backboard
13		Protective gloves	Wearing when installing the equipment
14		Safety goggles	Wearing when drilling holes
15		Mask	Wearing when drilling holes

Installation Environment

- Select a dry and clean place, for easy installation.
- Range of ambient temperature: -25°C~60°C .
- Relative humidity: 0~95% (non-condensing) .
- The inverter shall be installed in a well-ventilated area.
- The frequency converter shall be away from flammable and explosive materials.
- AC overvoltage category of the inverter shall be Class III .
- Maximum altitude: 4,000m.
- Avoid direct sunlight.
- Need to shelter from rain.
- Need to shelter from snow.

! When the inverter is installed, the wiring end faces the ground to ensure that the screen can read information normally and protect the machine from rain and snow.



Keep away from sunlight



Sun



Keep the inverter dry



Rain



Keep the inverter clear of snow



Accumulated snow



Mounting the Unit

1. Drill four holes in a suitable position on the wall, then insert screw fixing seat, align the wall mounting bracket hole position with the screw fixing seat, and tighten it with M8*50 Self-tapping screw to fix the bracket.
2. Hang up the inverter on the bracket, and then inner hexagon screws to fix the bracket and the inverter.

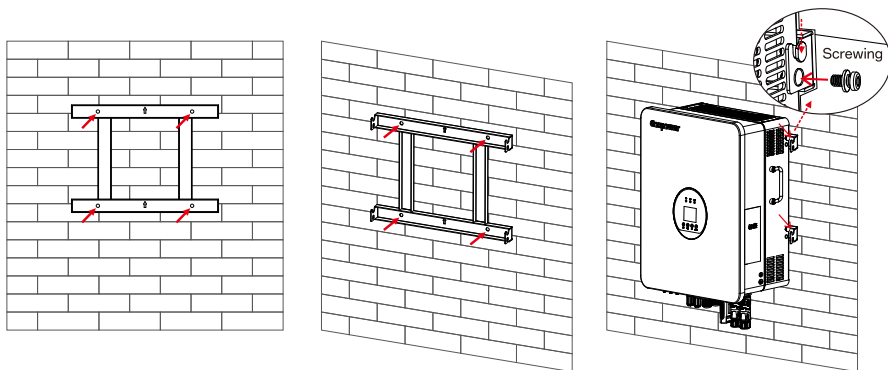

! When installing the wall mounting bracket, keep the arrow pointing up. Suitable for mounting on concrete or other non-combustible surface only.

In addition, leave enough space around the machine, the horizontal distance between the top and bottom is 300mm, and the horizontal distance between the left and right is 400mm. Ensure that the inverter has enough space for cabling and heat dissipation.

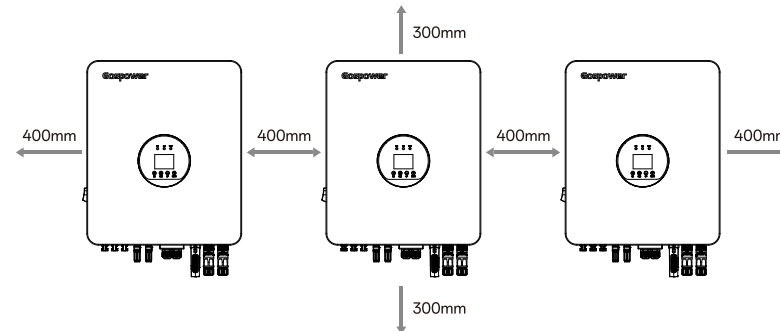

Connection of PV Cable

1. Strip the PV cable for about 20mm, remove the connector nut, thread the cable through the nut, and crimp the metal terminal using a crimping pliers and ensure fixed.
2. After crimping, insert the cable into the plastic terminal, tighten the nut, and then insert connector the inverter corresponding port according. (Please make sure that the cable is fully inserted. Once the cable is fully inserted, it will not be able to be pulled out.) As shown in figure:

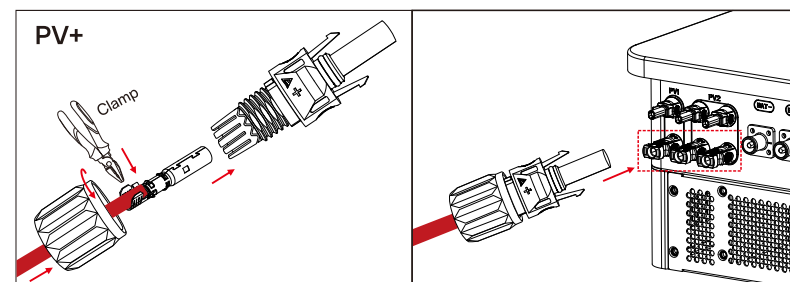
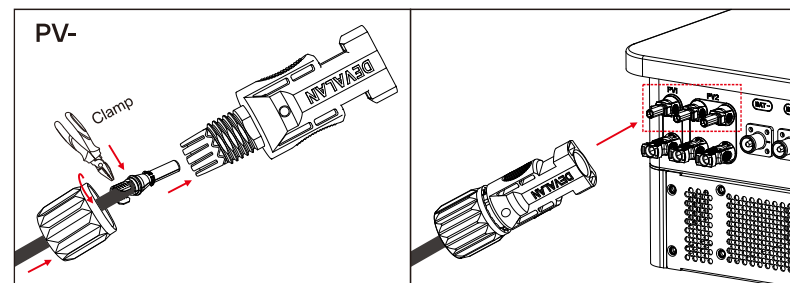
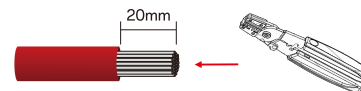

Connection of Battery Cable

1. Strip the BAT cable for about 12mm, remove the connector nut, thread the cable through the nut, insert it into the metal terminal and press it with the crimping clamp to ensure it is fixed.
2. After crimping, tighten the nut, and then insert connector the inverter corresponding port according. As shown in the figure:

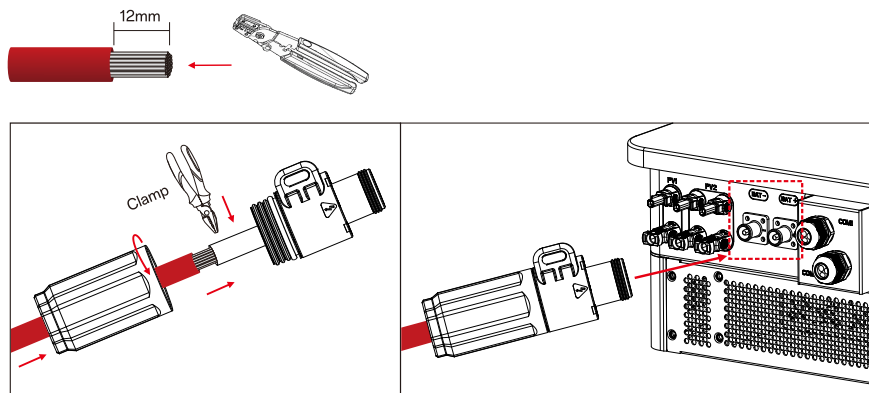

LOAD and GRID links

1. Strip the LOAD cable for about 15mm, remove the connector nut, thread the cable through the nut, in turn insert it into the metal terminal which corresponding to the identifier and cross screwdriver screw down to ensure it is fixed.
2. After installing in turn all five cable, tighten the nut, and then insert connector the inverter corresponding port according. As shown in the figure:

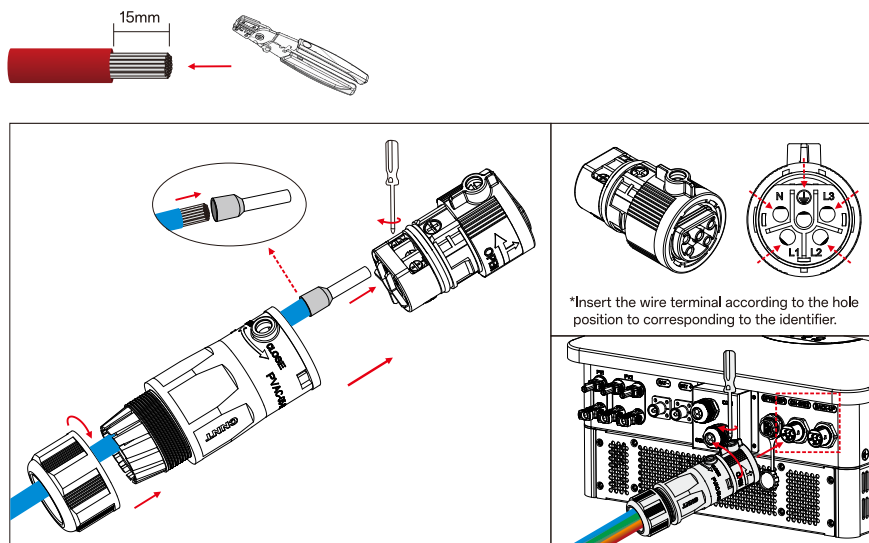

Communication Port

NOTE: Remove the external protective box using cross screwdriver firstly, route the cable through the protective box and connect it to the port, and install the protective box.

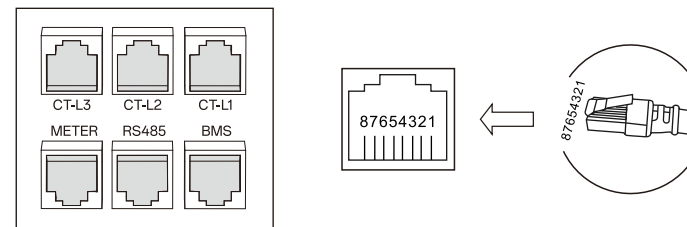
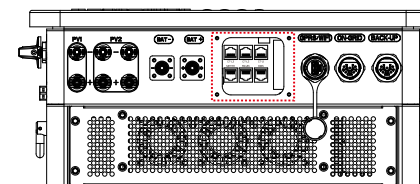
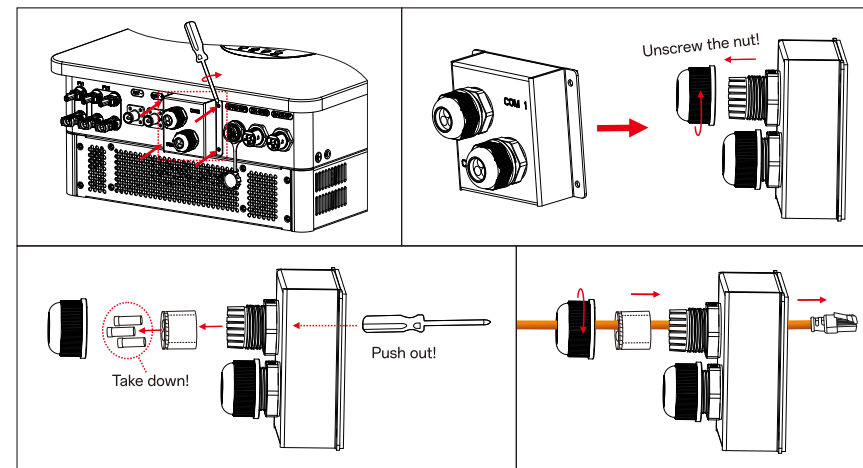

	PIN 1	PIN 2	PIN 3	PIN 4	PIN 5	PIN 6	PIN 7	PIN 8
RS485	485B	485A	/	/	/	/	485A	485B
METER	METER-485B	METER-485A	/	/	/	/	METER-485A	METER-485B
BMS	BMS-485B	BMS-485A	COM-GND	BMS-CONAH	BMS-COMAL	COM-GND	BMS-485A	BMS-485B

CT: The network ports are connected to CT-L1,CT-L2, and CT-L3, and the other end clips the mains output L1, L2, and L3 respectively.

WiFi Dongle Connection

Insert it into the USB port and lock it by turning the clamp to prevent it from falling. When disassembling, it is also necessary to rotate the snap first and then remove it.

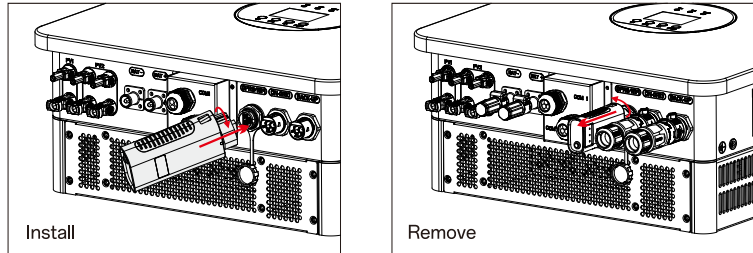

Wiring System for Inverter

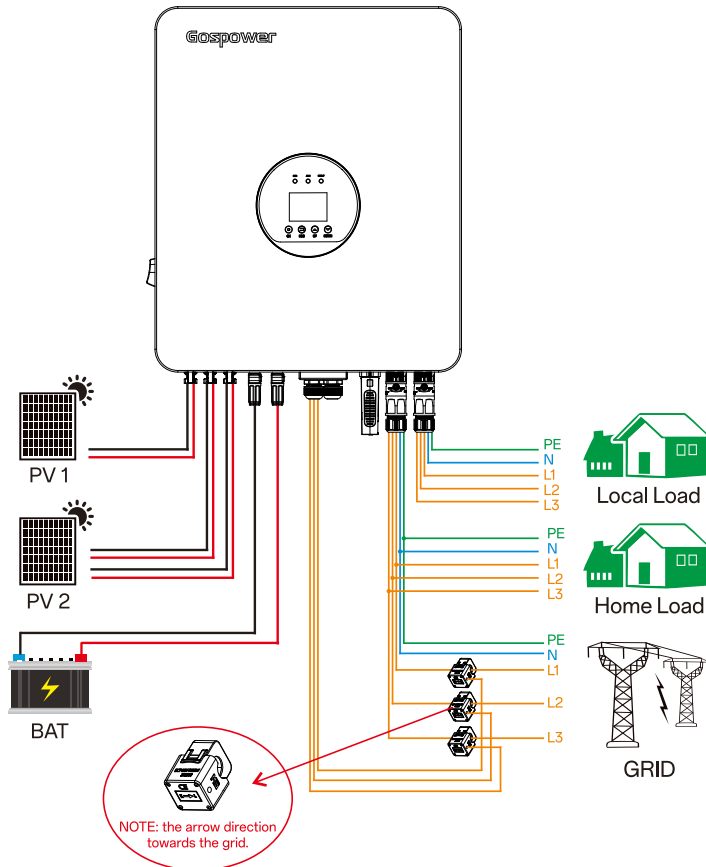

OPERATING INSTRUCTIONS

Power ON/OFF

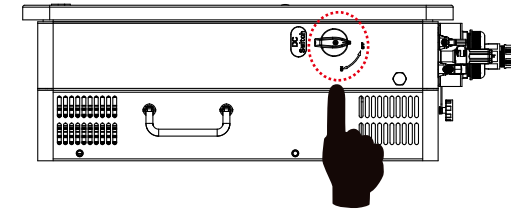

Once the unit has been properly installed and the battery is well connected, simply turn the ON/OFF switch (located on the left side of the machine) to turn on/off the unit.

Operation and Display Pane

The operation and display panel, shown in below chart, is on the front panel of the inverter. It includes three indicators, four function keys and a LCD display, indicating the operating status and input/output power information.

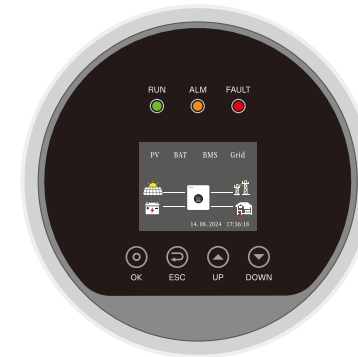

Function Key	Icon	Description
OK	⊙	To select the current menu option or switch to the next page
ESC	⊞	To return to the previous menu
UP	⬆	To return to the menu on the previous page or digit +1
DOWN	⬇	To go to the menu of next page or digit -1

Indicator lights and their status

Status	RUN Green Light	ALM Yellow Light	FAULT Red Light
Normal Run	Always On		
Alarm		Always On	
Fault			Always On

During normal operation, the inverter only shows the green light; when an abnormality occurs but does not affect the temporary operation of the inverter both the green and yellow lights will remain constantly on. The current alarm codes can be viewed through the Event List; when a fault occurs, the red light comes on, the display shows the fault code, and the inverter stops working; corresponding adjustments should be made to the alarm and fault codes according to the Warning/Fault Code Table.

LCD Display Icons

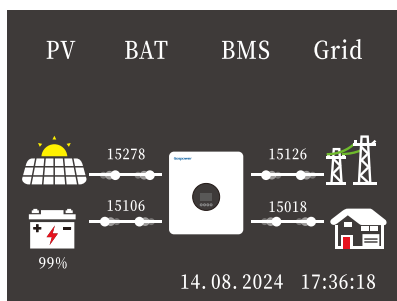

Icon	Function description
PV BAT BMS Grid	When the word lights up, it means that the corresponding module is connected.
	The icon indicates the charging and discharging of each module. PV can only be output, load can only be input, grid and BAT can be input or output.
14.08.2024 17:36:18	Represents day, month, year and real time.

Menu Function

Push “up” or “down”, enter the information interface:

PV information	Inv information	Grid information																																	
<table border="1"> <thead> <tr> <th>Volt</th> <th>Curr</th> <th>Power</th> </tr> </thead> <tbody> <tr> <td>PV1 0.0 V</td> <td>0.0 A</td> <td>0 W</td> </tr> <tr> <td>PV2 604.4 V</td> <td>20.0 A</td> <td>2140 W</td> </tr> </tbody> </table>	Volt	Curr	Power	PV1 0.0 V	0.0 A	0 W	PV2 604.4 V	20.0 A	2140 W	<table border="1"> <thead> <tr> <th>Volt</th> <th>Curr</th> <th>Power</th> </tr> </thead> <tbody> <tr> <td>INV L1 230.9 V</td> <td>8.9 A</td> <td>2005 W</td> </tr> <tr> <td>INV L2 232.3 V</td> <td>9.0 A</td> <td>2074 W</td> </tr> <tr> <td>INV L3 231.6 V</td> <td>9.0 A</td> <td>2059 W</td> </tr> </tbody> </table>	Volt	Curr	Power	INV L1 230.9 V	8.9 A	2005 W	INV L2 232.3 V	9.0 A	2074 W	INV L3 231.6 V	9.0 A	2059 W	<table border="1"> <thead> <tr> <th>Volt</th> <th>Freq</th> <th>Power</th> </tr> </thead> <tbody> <tr> <td>Grid L1 237.0 V</td> <td>50.01 Hz</td> <td>-1 W</td> </tr> <tr> <td>Grid L2 234.2 V</td> <td>50.00 Hz</td> <td>-7 W</td> </tr> <tr> <td>Grid L3 236.0 V</td> <td>50.02 Hz</td> <td>16 W</td> </tr> </tbody> </table>	Volt	Freq	Power	Grid L1 237.0 V	50.01 Hz	-1 W	Grid L2 234.2 V	50.00 Hz	-7 W	Grid L3 236.0 V	50.02 Hz	16 W
Volt	Curr	Power																																	
PV1 0.0 V	0.0 A	0 W																																	
PV2 604.4 V	20.0 A	2140 W																																	
Volt	Curr	Power																																	
INV L1 230.9 V	8.9 A	2005 W																																	
INV L2 232.3 V	9.0 A	2074 W																																	
INV L3 231.6 V	9.0 A	2059 W																																	
Volt	Freq	Power																																	
Grid L1 237.0 V	50.01 Hz	-1 W																																	
Grid L2 234.2 V	50.00 Hz	-7 W																																	
Grid L3 236.0 V	50.02 Hz	16 W																																	

Load information	Bat information																						
<table border="1"> <thead> <tr> <th>Volt</th> <th>Curr</th> <th>Power</th> </tr> </thead> <tbody> <tr> <td>Load L1 237.0 V</td> <td>8.8 A</td> <td>2109 W</td> </tr> <tr> <td>Load L2 234.2 V</td> <td>8.7 A</td> <td>2052 W</td> </tr> <tr> <td>Load L3 236.0 V</td> <td>8.7 A</td> <td>2080 W</td> </tr> </tbody> </table>	Volt	Curr	Power	Load L1 237.0 V	8.8 A	2109 W	Load L2 234.2 V	8.7 A	2052 W	Load L3 236.0 V	8.7 A	2080 W	<table border="1"> <thead> <tr> <th>Battery</th> <th>Temperature</th> </tr> </thead> <tbody> <tr> <td>Volt 403.1 V</td> <td>AC 46.9 °C</td> </tr> <tr> <td>Curr -12.9 A</td> <td>DC1 44.9 °C</td> </tr> <tr> <td>Temp --- °C</td> <td>DC2 42.3 °C</td> </tr> <tr> <td>SOC 69.0 %</td> <td>INT 38.0 °C</td> </tr> </tbody> </table>	Battery	Temperature	Volt 403.1 V	AC 46.9 °C	Curr -12.9 A	DC1 44.9 °C	Temp --- °C	DC2 42.3 °C	SOC 69.0 %	INT 38.0 °C
Volt	Curr	Power																					
Load L1 237.0 V	8.8 A	2109 W																					
Load L2 234.2 V	8.7 A	2052 W																					
Load L3 236.0 V	8.7 A	2080 W																					
Battery	Temperature																						
Volt 403.1 V	AC 46.9 °C																						
Curr -12.9 A	DC1 44.9 °C																						
Temp --- °C	DC2 42.3 °C																						
SOC 69.0 %	INT 38.0 °C																						

Push “OK”, enter the mainmenu:

Main Menu	Description
<ul style="list-style-type: none"> System Settings Advanced Settings Energy Statistics System Information Event List 	<p>The main menu is divided into five modules, click into the corresponding module to set or view the relevant information, as follows:</p> <p>System Settings: Set various modes and parameters.</p> <p>Advanced Settings: DC input setting, protecting setting, switch settings, and other settings.</p> <p>Energy Statistics: Displays total power generation and total power consumption.</p> <p>System Information: Hardware, software, local regulation, status and performance information.</p> <p>Event List: List and time of alarm and fault events.</p>

Common functional page:

<ul style="list-style-type: none"> System Settings Advanced Settings Energy Statistics System Information Event List 	<ul style="list-style-type: none"> ESS Mode Battery Settings Regulation Settings Output Volt Zero Export to Grid System Time 	<p>This page includes operating status, local regulation setting and system time setting.</p>												
<ul style="list-style-type: none"> ESS Mode Battery Settings Regulation Settings Output Volt Zero Export to Grid System Time 	<ul style="list-style-type: none"> General Mode Back-Up Mode Economic Mode 	<p>According to the actual condition select most appropriate ESS mode. The general mode is applicable to most scenarios, the backup mode ensures battery filled, and the economic mode use for gain most economic effectiveness.</p>												
<ul style="list-style-type: none"> ESS Mode Battery Settings Regulation Settings Output Volt Zero Export to Grid System Time 	<table border="1"> <thead> <tr> <th>Bat Type</th> <th>Lead Acid</th> </tr> <tr> <th>Bat Protocol</th> <th>Custom</th> </tr> </thead> <tbody> <tr> <td>Bat Pack Number</td> <td>6</td> </tr> <tr> <td>On Grid Cutoff SOC</td> <td>50 %</td> </tr> <tr> <td>Off Grid Cutoff SOC</td> <td>10 %</td> </tr> <tr> <td>Off Grid Recovery SOC</td> <td>40 %</td> </tr> </tbody> </table> <p>Page:1/2</p>	Bat Type	Lead Acid	Bat Protocol	Custom	Bat Pack Number	6	On Grid Cutoff SOC	50 %	Off Grid Cutoff SOC	10 %	Off Grid Recovery SOC	40 %	<p>Use for setting the battery type, communication mode, battery pack number, cut-off voltage, recovery voltage and charging and discharging current.</p>
Bat Type	Lead Acid													
Bat Protocol	Custom													
Bat Pack Number	6													
On Grid Cutoff SOC	50 %													
Off Grid Cutoff SOC	10 %													
Off Grid Recovery SOC	40 %													

	<p>Max CHG Curr A</p> <p>Max DSG Curr A</p> <p>Page: 2/2</p>	
<p>System Settings</p> <ul style="list-style-type: none"> Advanced Settings Energy Statistics System Information Event List 	<p>ON/OFF Ctrl</p> <p>PV Mode</p> <p>Battery Settings</p> <p>Grid Protection Settings</p> <p>Lithium BAT Activate</p> <p>Anti-Islanding Detection</p> <p>Clear Energy Record</p> <p>Clear Event Log</p> <p>Restore Factory Settings</p>	<p>PV Mode and Battery Settings belong to DC input setting, Grid Protection Settings and Anti-Islanding detection belong to protecting setting, ON/OFF Ctrl belong to switch settings, and the rest belong to other settings.</p>
<p>System Settings</p> <p>Advanced Settings</p> <ul style="list-style-type: none"> Energy Statistics System Information Event List 	<p>Energy Generation kWh</p> <p>Load Consumption kWh</p> <p>Purchase kWh</p> <p>Sales kWh</p> <p>Battery CEG kWh</p> <p>Battery DSG kWh</p> <p>Page: /4</p>	<p>Battery charge and discharge records, load consumption, battery power, power purchased and sold, and other data.</p>
<p>System Settings</p> <p>Advanced Settings</p> <p>Energy Statistics</p> <ul style="list-style-type: none"> System Information Event List 	<p>S/N</p> <p>PMU S/W VER</p> <p>DSP1 S/W VER</p> <p>DSP2 S/W VER</p> <p>Regulation</p> <p>Rated Power</p>	<p>System information introduction.</p>
<p>System Settings</p> <p>Advanced Settings</p> <p>Energy Statistics</p> <p>System Information</p> <ul style="list-style-type: none"> Event List 	<p>Current Faults Information</p> <p>History Faults Information</p> <p>History Warnings Information</p>	<p>Event recorded information.</p>

Working Mode

The inverter has three modes to choose from: General Mode, Back-Up Mode and Economic Mode.

Economic mode

When the inverter is in this mode, you can set a reasonable charge and discharge time according to the local electricity price fluctuations to obtain the greatest economic benefits.

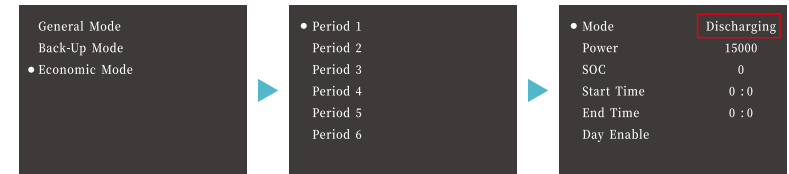

When set to “discharging”, the inverter discharges from the PV and battery to the load or grid.

- Load priority: LOAD>GRID>BAT
- Energy use priority: PV>BAT>GRID

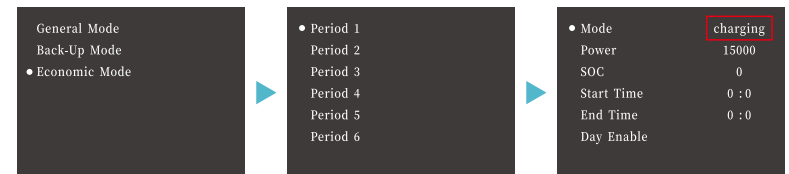

When set to “charging”, the inverter charges the battery from grid or PV.

- Load priority: LOAD>BAT>GRID
- Energy use priority: PV>GRID>BAT

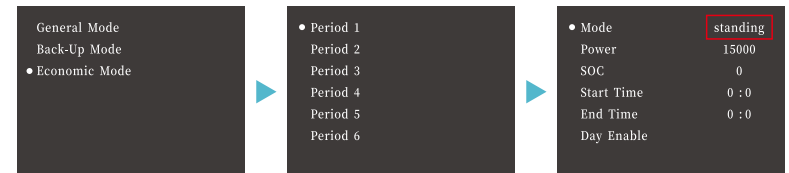

When set to “standing”, the inverter will be in General Mode, which will reduce the use of energy from the power grid, instead will use PV and battery power.

- Load priority: LOAD>BAT>GRID
- Energy use priority: PV>BAT>GRID

General mode

When the inverter is in this mode, PV energy is prioritized for loads, the excess energy is used to charge the battery, and the remaining is reserved for the power grid. PV and battery energy is always the preferred energy for loads, followed by the grid energy.

- Load priority: LOAD>BAT>GRID
- Energy use priority: PV>BAT>GRID

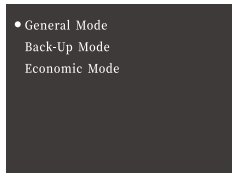

Back-up mode

When the inverter is in this mode, the inverter will prioritized to charge the battery under the premise of sufficient load energy.

- Load priority: LOAD>BAT>GRID
- Energy use priority: PV>GRID>BAT

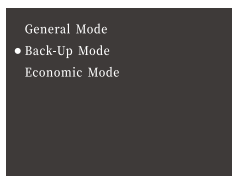

THINGS-X APP OPERATION INSTRUCTIONS

Download App

Scan the QR code:



Android QR code



iPhone QR code

• Link

Android link: https://thingsxapp.oss-cn-shenzhen.aliyuncs.com/things-x_latest.apk
 Apple link: <https://apps.apple.com/us/app/things-x/id1672227962>

Register & Login

After the application is installed, fill in your email account as shown below and click "Register". The system will send an email to your mailbox to activate your account. Click the link to activate the account, and fill in the account password, you can log in after the completion.

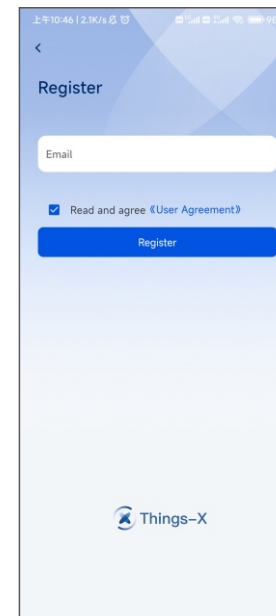
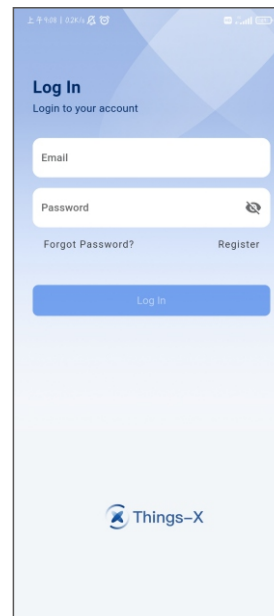

Power Station Creation

1. Enter the home page

Login the account which you just created, then click [+] in the upper right corner of [Home page], and select "Power Station" to enter the power station add page. (Figures 1-1 and 1-2)

2. Fill in power station details

Please fill in the information of the power station according to the prompts, including: name of the power station, type of the power station, system type, installed capacity and currency unit. It's important to note that the Things-X platform will analyze the data of the power station based on the installed capacity, so please fill in the data after confirming that there is no error. After filling in, click [Create] and then completes the creation of the plant. (Figures 1-3)

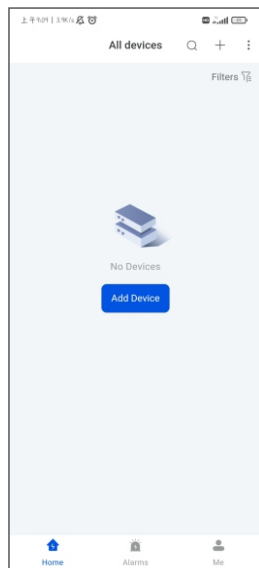

1-1

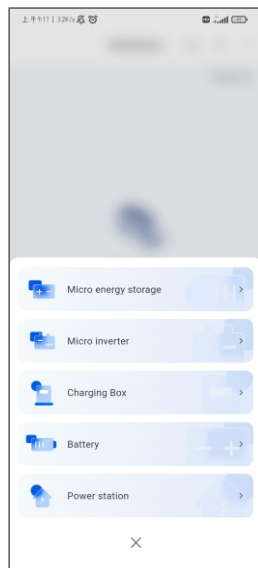

1-2

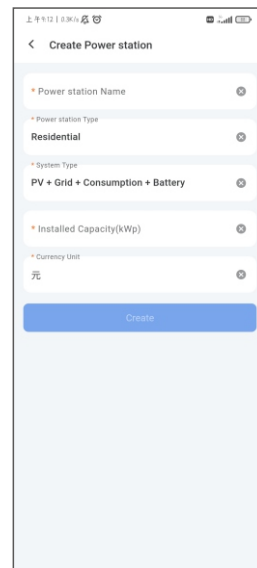

1-3

Bind Collector

When performing this operation, make sure to grant APP camera access permission and keep your phone's Bluetooth on.

Method 1: Scan the code to bind the collector

1. Scan the collector's QR code

Once the power station is created successfully, you will be automatically redirected to the [Power Station] - [Devices] page. Click [Add Device] to use the camera to scan the QR code on the collector. (Figures 2-1 and 2-2)

2. Fill in the relevant information of the collector

If the scan is successful, the system will automatically recognize the SN number of the collector and jump to the page for filling in the information of the collector. Fill in the password of the collector in this page (The password defaults to 123456), and then click [Bind] to successfully bind. (Figures 2-3)

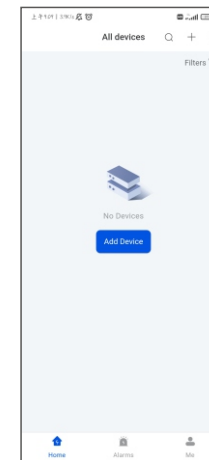

2-1



2-2

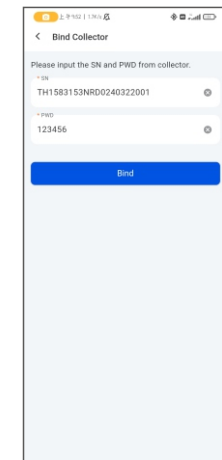

2-3

Method 2: Bluetooth bind the collector

1. From Bluetooth Click [Add Device], and there is an option "From Bluetooth" below the page (Figures 3-1). Click it to enter the device search page (Figures 3-2).

2. Choose the matched collector's SN sequence number, and then you will enter the page for filling in the information of the collector. The system will automatically recognize the SN number of the collector, fill in the password (The password defaults to 123456), and then click [Bind] to successfully bind (Figures 3-3).



3-1

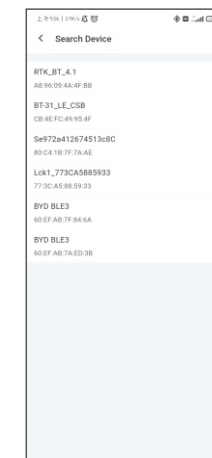

3-2

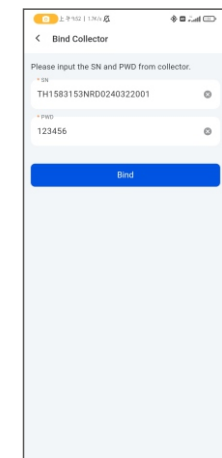

3-3

Method 3: Input device code to bind collector

Click [Add Device] (Figures 4-1), and there is an option "Input" at the bottom of the page (Figures 4-2). Click it to enter the page for filling in the information of the collector. Manually enter the SN number of the collector and password (The password defaults to 123456), and click [Bind] to successfully bind (Figures 4-3).

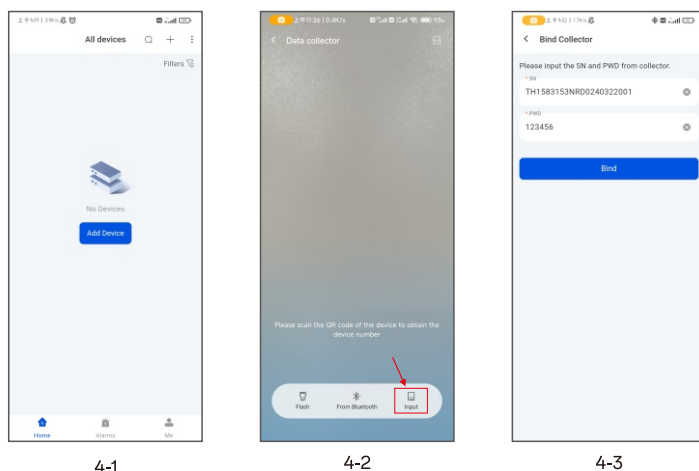

Collector Networking Step Explanation

After the collector is successfully bound, the system will automatically redirect to the WiFi configuration page. Configure the network of the collector to be able to monitor the relevant devices. Click [Go to Config] to proceed to the next step.

1. Open the bound collector information screen and click to enter the next screen (Figures 5-1).
2. Click the three dots in the top left corner of the page (Figures 5-2), and then click the Device WiFi Setup to into the next screen (Figures 5-3).
3. According to steps indicated on the page to operating, make sure the phone is connected to the WiFi Dongle (Figures 5-4).
4. After pairing with the device, enter the WiFi name and WiFi password, click [Confirm], and the network configuration will be completed (Figures 5-5). Return to the home page to view the data reporting of the device.

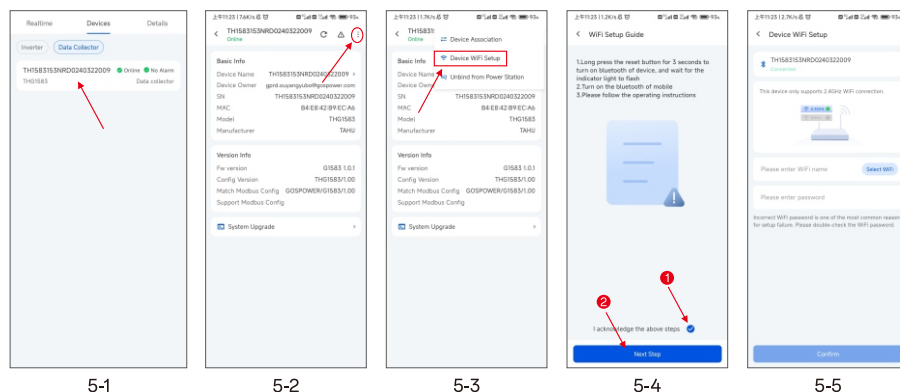

TECHNICAL PARAMETERS

Battery Parameters

Battery				
Model of inverter	GPEX-8KH3	GPEX-10KH3	GPEX-12KH3	GPEX-15KH3
Type of battery	Ternary lithium and lithium iron phosphate	Ternary lithium and lithium iron phosphate	Ternary lithium and lithium iron phosphate	Ternary lithium and lithium iron phosphate
Rated voltage (V)	400	400	400	400
Voltage range (V)	160-800	160-800	160-800	160-800
Maximum charging and discharging power (W)	8000	10000	12000	15000
Maximum charging and discharging current (A)	50(configurable)	50(configurable)	50(configurable)	50(configurable)
Battery capacity (Ah)	≥50(customized based on the needs)			
Charging mode	PV/AC (Charging mode adaptive BMS system)			
Maximum charging voltage (V)	800 (configurable)	800 (configurable)	800 (configurable)	800 (configurable)
Battery temperature compensation	Integrated (lithium battery)	Integrated (lithium battery)	Integrated (lithium battery)	Integrated (lithium battery)

PV Input Parameters

PV				
Model of inverter	GPEX-8KH3	GPEX-10KH3	GPEX-12KH3	GPEX-15KH3
Maximum allowable access string power (W)	22800	22800	22800	22800
Maximum DC voltage (V)	1000	1000	1000	1000
MPPT voltage range (V)	200-850	200-850	200-850	200-850
Rated voltage (V)	600	600	600	600
Starting voltage (V)	200	200	200	200
Maximum DC current (A)	15+30	15+30	15+30	15+30
MPPT paths	2	2	2	2
MPPT strings per channel	1+2	1+2	1+2	1+2
Type of DC terminal Mc4	MC4	MC4	MC4	MC4

DC switch (photovoltaic)	GHX5 (TUV certification)	GHX5 (TUV certification)	GHX5 (TUV certification)	GHX5 (TUV certification)
--------------------------	--------------------------	--------------------------	--------------------------	--------------------------

Output Parameters

AC (grid-connected)				
Model of inverter	GPEX-8KH3	GPEX-10KH3	GPEX-12KH3	GPEX-15KH3
Rated grid-connected output apparent power (VA)	8000	10000	12000	15000
Maximum grid-connected output apparent power (VA)	8800	11000	13200	16500
Grid type	three phase	three phase	three phase	three phase
Rated input frequency (Hz)	50/60	50/60	50/60	50/60
Voltage range (V)	320~480	320~480	320~480	320~480
Rated voltage (V)	400/380	400/380	400/380	400/380
Frequency range (Hz)	50±2% / 60±2%	50±2% / 60±2%	50±2% / 60±2%	50±2% / 60±2%
Maximum grid-connected current (A)	13	16	19.2	24
Maximum input current (A)	24	28	32	36
Total harmonic distortion of current (rated power)	< 3%	< 3%	< 3%	< 3%
Power factor	0.8 lead to 0.8 lag (adjustable)	0.8 lead to 0.8 lag (adjustable)	0.8 lead to 0.8 lag (adjustable)	0.8 lead to 0.8 lag (adjustable)
Switching time (network outage)	< 10ms	< 10ms	< 10ms	< 10ms
Anti-reflux	Yes	Yes	Yes	Yes
AC (off-grid)				
Model of inverter	GPEX-8KH3	GPEX-10KH3	GPEX-12KH3	GPEX-15KH3
Maximum AC power (W)	8000	10000	12000	15000
Rated frequency (Hz)	50/60 (optional)	50/60 (optional)	50/60 (optional)	50/60 (optional)
Frequency accuracy	±0.2Hz	±0.2Hz	±0.2Hz	±0.2Hz
Maximum output current (A)	13	16	19.2	24

Voltage stabilization accuracy	±1%	±1%	±1%	±1%
Voltage harmonics (full load)	THDV < 3% (Linear load)	THDV < 3% (Linear load)	THDV < 3% (Linear load)	THDV < 3% (Linear load)
Overload capacity	105% < load rate ≤ 125%, alarm and shutdown 10 minutes latter	105% < load rate ≤ 125%, alarm and shutdown 10 minutes latter	105% < load rate ≤ 125%, alarm and shutdown 10 minutes latter	105% < load rate ≤ 125%, alarm and shutdown 10 minutes latter
	125% < load rate ≤ 150%, alarm and shutdown 1 minute latter	125% < load rate ≤ 150%, alarm and shutdown 1 minute latter	125% < load rate ≤ 150%, alarm and shutdown 1 minute latter	125% < load rate ≤ 150%, alarm and shutdown 1 minute latter
	Load rate > 150%, alarm and shutdown 1s latter	Load rate > 150%, alarm and shutdown 1s latter	Load rate > 150%, alarm and shutdown 1s latter	Load rate > 150%, alarm and shutdown 1s latter

Efficiency and Protection

Efficiency				
Model of inverter	GPEX-8KH3	GPEX-10KH3	GPEX-12KH3	GPEX-15KH3
Maximum efficiency	98.00%	98.00%	98.00%	98.00%
European efficiency	97.5%	97.5%	97.5%	97.5%
MPPT efficiency	99.90%	99.90%	99.90%	99.90%
Maximum conversion efficiency of battery	97%	97%	97%	97%
Protection				
Residual current protection	Yes	Yes	Yes	Yes
Landing protection	Yes	Yes	Yes	Yes
Overvoltage and undervoltage protection	Yes	Yes	Yes	Yes
Battery and photovoltaic reverse connection protection	Yes	Yes	Yes	Yes
Output overcurrent protection	Yes	Yes	Yes	Yes
Output short circuit	Yes	Yes	Yes	Yes
Insulation impedance detection	Yes	Yes	Yes	Yes

General Parameters

General parameters				
Model of inverter	GPEX-8KH3	GPEX-10KH3	GPEX-12KH3	GPEX-15KH3
Dimensions (l * w * h)	520*430*200mm	520*430*200mm	520*430*200mm	520*430*200mm
Weight (kg)	28kg	29kg	30kg	31kg
Installation method	Wall-mounted	Wall-mounted	Wall-mounted	Wall-mounted
Maximum conversion efficiency of battery	-20~60°C (>45 °C load shedding or derating)	-20~60°C (>45 °C load shedding or derating)	-20~60°C (>45 °C load shedding or derating)	-20~60°C (>45 °C load shedding or derating)
Relative humidity	0~90%	0~90%	0~90%	0~90%
Maximum working altitude (m)	4,000m	4,000m	4,000m	4,000m
Protection level	Ip65	Ip65	Ip65	Ip65
Topological structure	No transformer (grid side)	No transformer (grid side)	No transformer (grid side)	No transformer (grid side)
Standby power consumption (W)	< 15	< 15	< 15	< 15
Cooling method	Natural convection	Natural convection	forced air cooling	forced air cooling
Noise index (db)	<25	<25	<55	<55
Display method	LCD screen; APP	LCD screen; APP	LCD screen; APP	LCD screen; APP
Communication mode	Wi-Fi; R485; CAN; Bluetooth (4G reserved)	Wi-Fi; R485; CAN; Bluetooth (4G reserved)	Wi-Fi; R485; CAN; Bluetooth (4G reserved)	Wi-Fi; R485; CAN; Bluetooth (4G reserved)
Warranty period (years)	5	5	5	5

Performance and Safety Regulation

Technical parameters	GPEX-8KH3	GPEX-10KH3	GPEX-12KH3	GPEX-15KH3
Display	LCD			
Monitoring	Bluetooth / RS485 / WIFI / GPRS (optional) / CAN2.0			
Standard warranty	5 years (renewable)			
Grid-connected standard	VDE4105, IEC61727/62116, VDE0126, AS4777.2, CEI 0 21, EN50549-1,G98, G99, C10-11, UNE217002, NBR16149/NBR16150			
Safety regulation standard	IEC/EN 61000-6-1/2/3/4, IEC/EN 62109-1, IEC/EN 62109-2			
EMC	IEC/EN 61000-6-1/2/3/4, IEC/EN 62109-1, IEC/EN 62109-2			

WARNING CODE TABLE

When warning event happens, the warning LED is lighting, but the warning information is not shown on the LCD. Go to the "Current Faults" page to view the warning information.

Warning code	Warning Information	Trouble shooting
W001	PV1 Over Volt	Please check whether the configuration of the PV panels meets the specifications of the inverter. If the problem persists, please contact the technical support.
W002	PV2 Over Volt	
W004	PV1 Under Volt	The alert will be cleared after PV has enough energy.
W005	PV2 Under Volt	
W007	No Battery	The alert will be cleared after Battery plugged in.
W008	Battery Under Volt	The alert will be cleared after charging the battery.
W010	Over Load	Please check if the inverter is operating in an overload state. If so, please reduce the load power and restart it.
W011	Grid Over Volt Lv1	After the power grid is normal, the inverter will clear the alerts.
W012	Grid Over Volt Lv2	
W013	Grid Under Volt Lv1	
W014	Grid Under Volt Lv2	
W015	Grid Over Freq Lv1	
W016	Grid Over Freq Lv2	
W017	Grid Under Freq Lv1	
W018	Grid Under Freq Lv2	
W019	Grid 10mins Over Volt	
W022	Freq Derating	
W023	Freq Derating Recovery	
W026	Phase Error	This alarm will be cleared when the phase of the power grid is correct.
W027	Anti-isla. Detection Effect	After the power grid is normal, the inverter will clear the alerts.
W028	DCDC Over Temp	Check whether the working environment temperature is too high.
W029	Internal ambient temperature Over Temp	Check whether the work environment temperature is too high; Turn off the inverter for 10 mins and restart; If can not go back to normal state, please contact technical support.
W030	INV Over Temp	Check whether the working environment temperature is too high.
W035	Fan 1 Abnormal Conditions	This alarm will be cleared when the fan works properly.
W036	Fan 2 Abnormal Conditions	

W042	Remote Shutdown	Please check whether the battery is charging properly, the alarm will be cleared when the battery charging properly.
W045	EEPROM 1 Abnormal Conditions	Internal failure of the inverter, turn off the inverter, wait for 5 minutes, and then turn on the inverter. Check if the problem has been resolved. If not, please contact technical support.
W046	EEPROM 2 Abnormal Conditions	
W051	Stop Charging	Please check whether the battery is charging properly, the alarm will be cleared when the battery charging properly.
W052	Stop Discharging	
W053	Force Charging	
W055	Lithium BAT Activate	The inverter will forcefully charge the battery to ensure it can be awakened. If the alarm persists, please contact technical support.
W056	No Grid	After the power grid is normal, the inverter will clear the alerts.
W057	BAT Cutoff Discharging	The alert will be cleared after charging the battery.
W061	PV Over Curr	Internal failure of the inverter, turn off the inverter, wait for 5 minutes, and then turn on the inverter. Check if the problem has been resolved. If not, please contact technical support.
W062	PV Over Curr	
W067	DC-side fan fault	Check if anything is blocking the fan. If not, please contact technical support.
W068	DC-X side fan fault	
W069	INV measurement fan fault	
W070	CT inspection abnormality	Internal failure of the inverter, turn off the inverter, wait for 5 minutes, and then turn on the inverter. Check if the problem has been resolved. If not, please contact technical support.
W071	BMS Data Error	
W072	Line Abnormal Access	
W073	BAT SOC lower than On Grid discharge SOC	
F097	PMU Comm Fault with DSP 1	Internal failure of the inverter, turn off the inverter, wait for 5 minutes, and then turn on the inverter. Check if the problem has been resolved. If not, please contact technical support.
F098	PMU Comm Fault with DSP 2	
F099	PMU Comm Fault with BMS	
F100	No Meter	
F101	DSP 1 Comm Fault with DSP 2	
F102	DSP 2 Comm Fault with DSP 1	

FAULT CODE TABLE

When fault event happens, inverter will cut off output, the fault LED is lighting, the fault information and "Fault Mode" are shown on the LCD. At the same time, the buzzer alarm will always go off.

Fault code	Fault Information	Trouble shooting
F001	PV OVER Volt	Please check whether the configuration of the PV panels meets the specifications of the inverter. If the problem persists, please contact the technical support.
F002	PV Input Over Curr	Internal failure of the inverter, turn off the inverter, wait for 5 minutes, and then turn on the inverter. Check if the problem has been resolved. If not, please contact technical support.
F004	PV Short Circuit	Check if there is a short circuit between the positive and negative terminals. If not, please contact the seller to apply for technical support.
F006	PV Senser Fault	Internal failure of the inverter, turn off the inverter, wait for 5 minutes, and then turn on the inverter. Check if the problem has been resolved. If not, please contact technical support.
F007	BAT Over Volt	Check whether the battery voltage matches the set number of batteries. If the matching situation still does not solve the problem, please contact technical support.
F010	DCDC Soft Start Out of Time	Internal failure of the inverter, turn off the inverter, wait for 5 minutes, and then turn on the inverter. Check if the problem has been resolved. If not, please contact technical support.
F011	DCDC Over Curr	
F015	Positive DCDC Senser Fault	Internal failure of the inverter, turn off the inverter, wait for 5 minutes, and then turn on the inverter. Check if the problem has been resolved. If not, please contact technical support.
F016	Negative DCDC Senser Fault	
F017	Output Over Load	Please check if the inverter is operating in an overload state. If so, please reduce the load power and restart it.
F019	INV Output Short Circuit	Internal failure of the inverter, turn off the inverter, wait for 5 minutes, and then turn on the inverter. Check if the problem has been resolved. If not, please contact technical support.
F020	AC Port connect error	Check if the AC terminals are connected correctly. If not, please contact technical support.
F021	Output Curr Senser Fault	Internal failure of the inverter, turn off the inverter, wait for 5 minutes, and then turn on the inverter. Check if the problem has been resolved. If not, please contact technical support.
F022	INV Output Volt Low	Internal failure of the inverter, turn off the inverter, wait for 5 minutes, and then turn on the inverter. Check if the problem has been resolved. If not, please contact technical support.
F023	INV Output Volt High	
F024	INV SW Over Curr	

F025	INV HW Over Curr	
F026	INV Soft Start Fault	Internal failure of the inverter, turn off the inverter, wait for 5minutes, and then turn on the inverter. Check if the problem has been resolved. If not, please contact technical support.
F027	INV DC Sensor Fault	Internal failure of the inverter, turn off the inverter, wait for 5 minutes, and then turn on the inverter. Check if the problem has been resolved. If not, please contact technical support.
F028	INV DC Abnormal Conditions	Internal failure of the inverter, turn off the inverter, wait for 5 minutes, and then turn on the inverter. Check if the problem has been resolved. If not, please contact technical support.
F029	INV Sensor Fault	Internal failure of the inverter, turn off the inverter, wait for 5 minutes, and then turn on the inverter. Check if the problem has been resolved. If not, please contact technical support.
F030	BUS Under Volt	Internal failure of the inverter, turn off the inverter, wait for 5minutes, and then turn on the inverter. Check if the problem has been resolved. If not, please contact technical support.
F031	BUS Over Volt	
F032	BUS Imbalance	
F033	BUS Soft Start Out of Time	
F034	Circuit Over Temp	Please ensure that the inverter is installed in a place without direct sunlight, and ensure that the inverter is installed in a cool and well ventilated place. Ensure that the inverter is installed vertically and the ambient temperature is less than the upper limit of the inverter 's temperature.
F035	INV Over Temp	
F037	Fan Locked	Check if anything is blocking the fan. If not, please contact technical support.
F038	GFCI Fault	Check the PV cable ground connection; Restart the inverter 2-3 times; If the fault still existing, please contact technical support.
F039	GFCI Sensor Fault	Internal failure of the inverter, turn off the inverter, wait for 5 minutes, and then turn on the inverter. Check if the problem has been resolved. If not, please contact technical support.
F040	PV Isolation Fault	Check whether the connection of PV panels and inverter is firmly and correctly. Check whether the PE cable of inverter is connected to ground. If the problem isn't solved, please contact technical support.
F041	Balanced Bridge Over Curr	Internal failure of the inverter, turn off the inverter, wait for 5minutes, and then turn on the inverter. Check if the problem has been resolved. If not, please contact technical support.
F042	Relay Fault	
F050	EEPROM Fault	
F051	DSP 1 Comm Fault with DSP 2	

F053	PV Parallel Fault	Internal failure of the inverter, turn off the inverter, wait for 5minutes, and then turn on the inverter. Check if the problem has been resolved. If not, please contact technical support.
F054	No Temp Sensor	
F055	BAT Short Circuit	Internal failure of the inverter, turn off the inverter, wait for 5 minutes, and then turn on the inverter. Check if the problem has been resolved. If not, please contact technical support.
F056	Ext CT Sensor Fault	
F057	PV Over Curr	Internal failure of the inverter, turn off the inverter, wait for 5 minutes, and then turn on the inverter. Check if the problem has been resolved. If not, please contact technical support.
F058	Buckboost 1 Over Curr	
F059	Buckboost 2 Over Curr	
F087	BAT Input Short Circuit	Check if there is a short circuit between the positive and negative terminals. If not, please contact the seller to apply for technical support.